

## ■ Introduction

Vee-Lok tube fittings are designed to provide a leak-free connection and applied in chemical, petrochemical, oil refineries, shipbuilding, power generation and pulp and papers. The double ferrule design is a mechanism used for sealing and gripping tubing. Through the mechanical advantage and geometry, the tube fitting can overcome the variations in materials, wall thickness and hardness to provide an excellent seal performance.

The tube fitting consists of four parts: body, front ferrule, back ferrule and nut. The two ferrules separate sealing and tube gripping function and achieve excellent leak-free performance.

## ■ Features

When the nut is tightened, the back and front ferrules move axially. The axial movement does not allow any torque transfer from the fitting to tubing and the mechanical properties of tubing are maintained. The front ferrule creates a seal against the fitting body and on the tubing outside diameter while the back ferrule axially advances the front ferrule and radially provides an effective tube grip.

## ■ Material

Vee-Lok twin ferrule tube fittings are made of 316 stainless steel and supplied in metric and imperial sizes from 6mm O.D. to 25mm O.D. and 1/8"O.D. to 1"O.D. Straight fittings are machined from bar stock conforming to ASTM A276, ASME SA479, ASTM A479 and shaped bodies from forging ASME SA182 and ASTM A182.

## ■ Easy Reference

Heads of tables are differentiated with color below:

 Identifies fractional size

 Identifies metric size

## ■ Pressure Ratings

The pressure ratings of the Vee-Lok tube fittings are determined by the wall thicknesses of tubings on which they are installed. The maximum working pressure of tubings are listed in MAWP Table on following page.



### Note:

*Material strength and allowable working pressure decrease as the temperature increases*

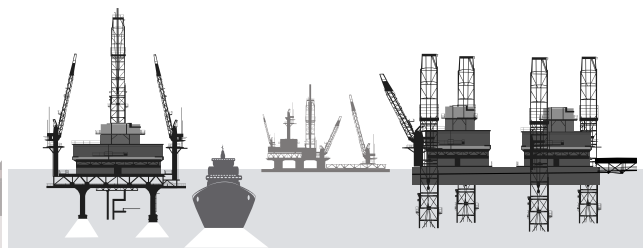
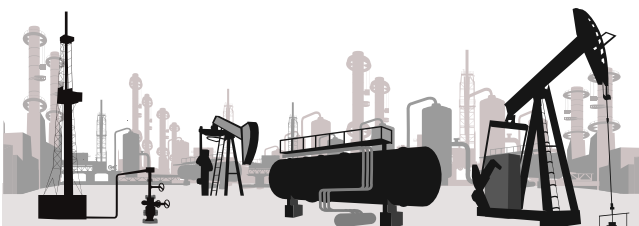

## ■ Temperature Ratings

316 stainless steel: -321°F to 1200°F (-196°C to 649°C)

## ■ Tubing

In order to ensure reliable and leak-free installation, tubing should be considered as one of fitting components.

## ■ Tubing Selection

### Hardness

- The metal tubing must be softer than the fitting materials. In general, it is recommended a fully annealed 304 or 316 stainless steel tubing meeting ASTM A269 or equivalent with hardness Rockwell HRB80 or less to work properly with VEE-LOK tube fittings.

### Surface

- Tubing must have a smooth surface free from dirt, scratches, weld seam and draw mark.

### Ovality

- Do not force the tubing into the fitting when tubing is oval or out of roundness. It may damage the fitting sealing mechanism on nut, ferrules and body.

### Wall thickness

- Temperature, pressure, vibration and shock conditions must be considered when selecting the wall thickness. A too thin wall may collapse and too thick wall may not be properly deformed by ferrule action.

### Tubing Handling

- Tubing ends should be capped to keep from dirt during transportation and storage.
- Do use correct tube cutter to avoid excessive deformation.
- Do deburr tube ends prior to installation.

**Use good quality tubing for the best performance.**

## ■ Gas Application

Gases have very small molecules and can escape even the most minute leak path because of surface imperfections.

Do not use thin wall tubing for gas applications. Heavier wall tubing resists the ferrule action more than thin wall does. The minimum wall thickness for gas application is shown for reference.

## ■ Fractional Tubing

Tubing O.D.	Nominal Min. Wall Thickness	Tubing O.D.	Nominal Min. Wall Thickness
1/8"	0.028"	1/2"	0.049"
1/4"	0.028"	5/8"	0.065"
5/16"	0.035"	3/4"	0.065"
3/8"	0.035"	1"	0.083"

## ■ Metric Tubing

Tubing O.D.	Nominal Min. Wall Thickness	Tubing O.D.	Nominal Min. Wall Thickness
6mm	0.8mm	16mm	1.5mm
8mm	1.0mm	18mm	1.5mm
10mm	1.0mm	20mm	1.8mm
12mm	1.0mm	22mm	2.0mm
15mm	1.2mm	25mm	2.2mm

## ■ Temperature Derating

The working pressure varies depending on temperature. The working pressure at various temperatures can be obtained by multiplying the working pressure at ambient temperature (-20°F to 100°F or -29°C to 37°C) by the temperature derating factor in the table below.

Temperature (°F)	316 SS
100	1.00
200	1.00
300	1.00
400	0.96
500	0.90
600	0.85
700	0.82
800	0.79
900	0.78
1000	0.76
1100	0.62
1200	0.37

## ■ Example

To obtain the working pressure of 316SS 1/4"O.D. x 0.035" wall tube at 800°F

- Working pressure of the above tubing at ambient temperature: 5,100 psi
- Temperature derating factor at 800°F: 0.79
- Working pressure at 800°F: 4,029 psi (from 5,100 psi multiplied by 0.79)

## ■ Maximum Allowable Working Pressure Table

Fully annealed austenitic type 304 or 316 seamless tubing ASTM A269 or ASTM A213, or equivalent. Tubing to be free from dirt, scratches, weld seam, draw mark and suitable for bending and flaring. Recommended hardness: 80 HRB or less.

Stainless Steel Tube Inch Size				
Tube O.D. (Inches)	Tube Wall Thickness in Inches			
	0.035	0.049	0.065	0.083
1/8"	10,900	7,500		
1/4"	5,100	5,800	10,200	Working Pressure in psig
5/16"	4,000	4,800	8,000	
3/8"	3,300	3,700	6,500	
1/2"	2,600	2,400	5,100	6,700
3/4"	For gas service, applying the wall thickness only on outside of shade boundary	2,000	3,300	4,200
7/8"			2,800	3,600
1"			2,400	3,100

Stainless Steel Tube Metric Size							
Tube O.D. (mm)	Tube Wall Thickness in Millimeters						
	0.89	1.00	1.24	1.50	1.65	2.00	2.20
6	6,500	7,400	9,400	11,500	12,700		
8	4,700	5,800	6,800	8,400	9,300	Working Pressure in psig	
10	3,700	4,200	5,300	6,500	7,300		
12	3,000	3,400	4,400	5,300	5,900	6,600	7,000
16		2,500	3,200	3,900	4,300	5,300	5,700
18	For gas service, applying the wall thickness only on outside of shade boundary		2,800	3,400	3,800	4,700	5,000
20			2,500	3,000	3,400	4,200	4,400
22			2,300	2,800	3,000	3,800	4,000
25			2,000	2,400	2,700	3,300	3,500

- Allowable stress of 20,000 psi between -20°F and 100°F (-29°C and 37°C) based on ultimate tensile strength 75,000 psi
- Based on minimum wall thickness and maximum O.D. allowable by ASTM A269

### Note:

1. Pressure calculations are based on maximum O.D. and minimum wall thickness without allowance for corrosion and erosion.
2. Figures shown are not for design purpose but for reference only. The accuracy of information here is not liability of our company.

## ■ Identification of Metric Size

Metric tube fittings are machined with the stepped shoulders on the body and the hex nut for identification. The metric nut must not be used on fractional body, and vice versa.



## ■ Sealing

### Taper Thread

NPT, BSPT (BS21) and ISO7/1 taper threads must use a thread sealant and proper lubrication to provide leak-free connection and prevent from galling that is mostly common in stainless steel.

### ISO Parallel Thread

With ISO 228/1, BSPP (BS2779) parallel thread requires a sealing washer. This seal may either be a metal (copper is standard) gasket or a "Bonded Seal" (elastomer bonded to a metal retaining washer). See 2 different seals below.

### Form A

No reverse angle is used. A self centering taper is used at hex which centers a "Bonded" washer seal ( usually metal and elastomer" to seal the surface surrounding the female thread.

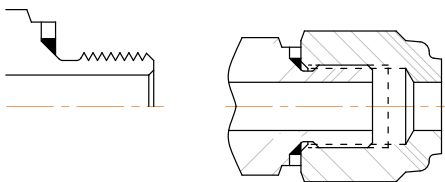

### Form B

A metal gasket (usually copper) gasket performs the sealing between the face of body and the surface surrounding the female threads.

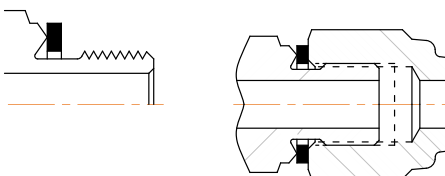

## ■ Installation Instructions

VEE-LOK two ferrule tube fittings are supplied finger tight and ready for immediate use. A leak tight and mechanically safe installation is easily made by turning the nut 1.1/4 turns or 3/4 turn for a smaller size in 1/8" O.D.

Prior to installation, make sure to have tube end cut 90 degree and remove burrs from inside and outside tube ends.



1. Insert well prepared tubing into VEE-LOK two ferrule tube fittings until tubing end is firmly seated on the body shoulder.

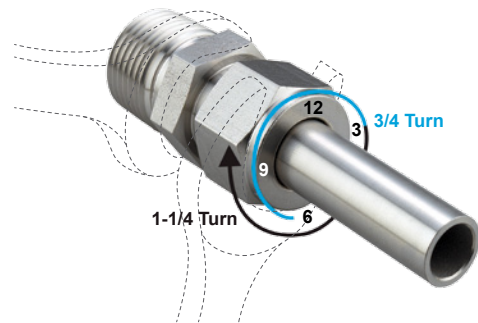

2. Mark the nut at position no.6 for identification of starting point to count the number of turns.
3. When holding the fitting body with a wrench to prevent the body from turning, tighten the nut with another wrench 1.1/4 turns to position no.9.

### Note:

*It is the responsibility of users to use the products for their specific application and adequately apply sealant and lubrication to system installation.*

*Improper installation or intermixing components of other manufacturers may cause personal injury or property losses.*

## ■ Ordering Information

Example 1: Tube to Pipe ends

**M MC 8- 4 BSPT**  
 ① ② ③ ④ ⑤

- ① "M" is prefixed to designate metric VEE-LOK tube fittings. Fractional size remains blank.
- ② Name of Fitting (MC=Male Connector)
- ③ Tube O.D. Designator
- ④ Pipe Thread Designator
- ⑤ "BSPT" or "BSPP" is to specify thread type. NPT thread remains blank.

Example 2: Tube to Tube ends

**M U 6**  
 ① ② ③

- ① "M" is prefixed to designate metric VEE-LOK tube fittings.
- ② Name of Fitting (U=Union)
- ③ Tube O.D. Designator

Example 3: Tee & Cross

In tee shown below, "1" and "2" are referred to as run and "3" is referred to as branch.

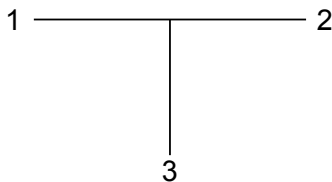

In cross shown below, "1" and "2" are referred to as run and "3" and "4" are referred to as branch.

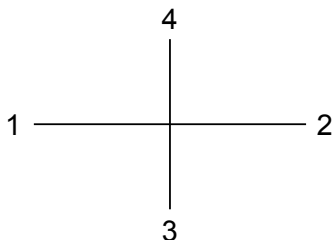

Fitting Name Designator	
Identifier	Description
MC	Male Connector
BMC	Bulkhead Male Connector
ME	Male Elbow
MRT	Male Run Tee
MBT	Male Branch Tee
UT	Union Tee
U	Union
RU	Reducing Union
BU	Bulkhead Union
UE	Union Elbow
UC	Union Cross
FC	Female Connector
BFC	Bulkhead Female Connector
FE	Female Elbow
FRT	Female Run Tee
FBT	Female Branch Tee
R	Reducer
MA	Male Adapter
FA	Female Adapter
N	Nut
BF	Back Ferrule
FF	Front Ferrule
P	Plug
CP	Cap

Tube O.D. Designator			
Inch O.D.	Identifier	Metric O.D.	Identifier
1/8	1	6	6
1/4	4	8	8
5/16	5	10	10
3/8	6	12	12
1/2	8	16	16
3/4	12	20	20
1	16	25	25

Pipe Thread Designator							
Nominal Size	1/8"	1/4"	3/8"	1/2"	3/4"	1"	Applicable Specifications
NPT	2	4	6	8	12	16	ANSI B1.20.1 (NPT)
ISO Tapered	2BSPT	4BSPT	6BSPT	8BSPT	12BSPT	16BSPT	BS 21(BSPT), ISO7/1, JIS B0203(PT)
ISO Parallel	2BSPP	4BSPP	6BSPP	8BSPP	12BSPP	16BSPP	BS 2779 (BSPP), DIN ISO 228/1, JIS B0202(PF)

# Index

General Information 01~04

Ordering Information 05

## Tube to Male Pipe

Male Connector  
**MC** 07~08

Bulkhead  
Male Connector  
**BMC** 09

Male Elbow  
**ME** 10~11

Male Run Tee  
**MRT** 12

Male Branch Tee  
**MBT** 13

## Tube to Female Pipe

Female Connector  
**FC** 14

Bulkhead  
Female Connector  
**BFC** 15

Female Elbow  
**FE** 16

Female Run Tee  
**FRT** 17

Female Branch Tee  
**FBT** 18

## Tube to Tube Union

Union Tee  
**UT** 19

Union  
**U** 20

Reducing Union  
**RU** 21

Bulkhead Union  
**BU** 22

Union Elbow  
**UE** 23

Cross Union  
**CU** 24

## Port Connector

Reducer  
**R** 25~26

Male Adapter  
**MA** 27

Female Adapter  
**FA** 28

## Component

Nut  
**N** 29

Back Ferrule  
**BF** 30

Front Ferrule  
**FF** 31

Plug  
**P** 32

Cap  
**CP**