

PNEUMATIC ACTUATOR

Pneumatic Actuator



Design and Construction

- Automa actuator is designed for rotary type valve.
- Automa provides various size of actuator, including heavy-duty actuator, to meet the customer's needs.
- Automa is in compliance with NAMUR and ISO Standard which enable us to fit with Valves & Accessories easily & simply
- Automa is Specialized in providing a wide range of industrial solutions such as petrochemical, Power generation, atomic power plant, steel inill, shipyard, refining, wastewater disposal, automation facilities and building air conditioner.

Specification

- Operating Pressure Range
Double Acting : 4~7kg/cm²
Single Acting : 4.5~7kg/cm²
- Operating Temperature Range
Standard : -20C° ~ 80C°
Option : -40C° ~ 200C°
- Cycle Life
1,300,000 Operating
- Rotating Angle Range

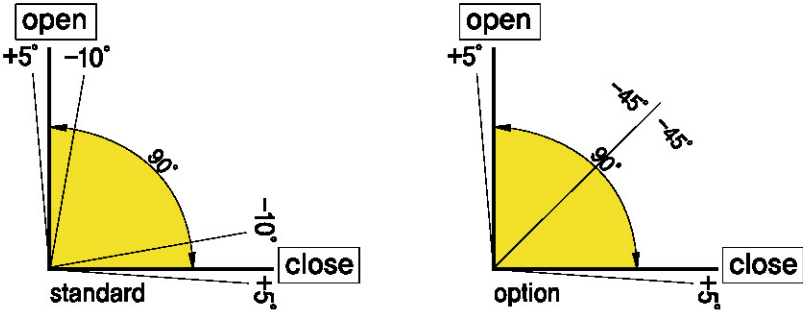

SCOTCH YOKE TYPE

Part List

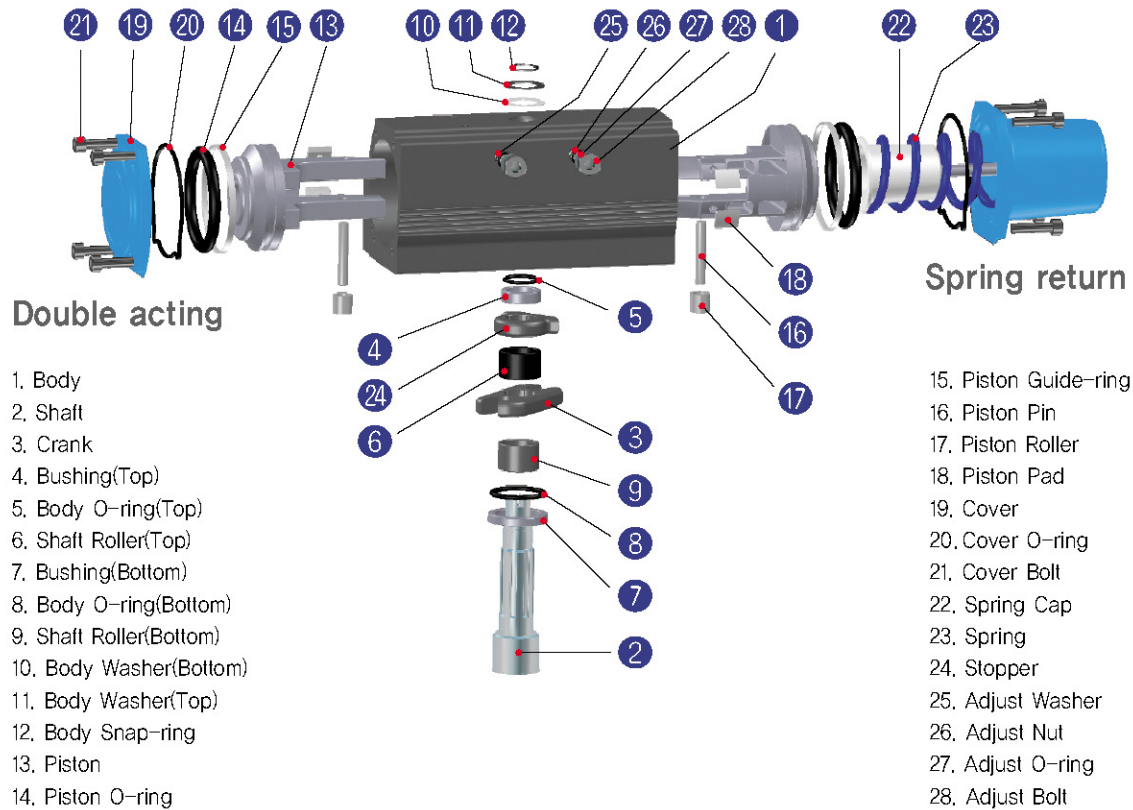

Pneumatic Rotary Actuator Applications

The Side Direction

- A. Side Handle
- B. Middle Torque Spring
- C. Strong Torque Spring

The Back Direction

- A. Adjust Bolt
- B. $-5^{\circ} \sim 95^{\circ}$ Stopper

The Top Direction

- A. Position Indicator
- B. Limit Switch Box
- C. Proximity Sensor
- D. E/P Positioner
- E. Position Transmitter
- F. Manual Lever

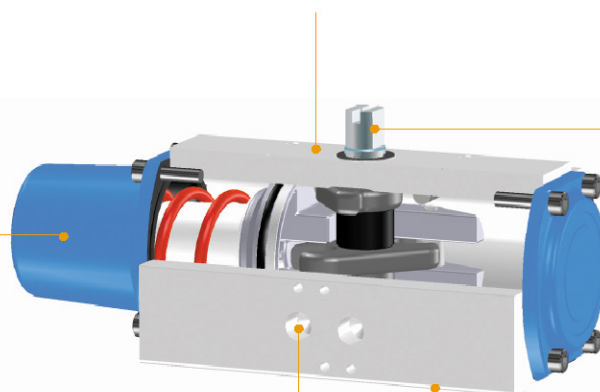

The Front Direction

- A. Solenoid Valve(NAMUR)
- B. Lock Up Valve
- C. Volume Booster
- D. Direct Fitting Assembler

The Bottom Direction

- A. Valve Mounting
- B. Declutch Gear Box
- C. ISO 5211 DIN 3337 Square & Holes

A SERIES (DOUBLE ACTING)

SCOTCH YOKE TYPE

Dimension

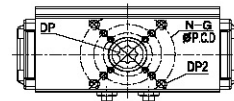
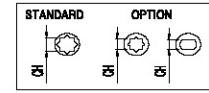
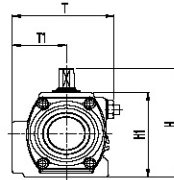
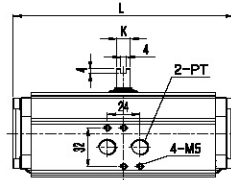
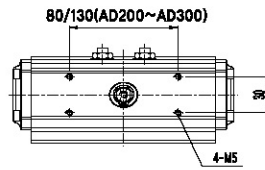

(mm)

2-PT	
AD50~AD200	PT1/4
AD250~AD300	PT1/4
	PT3/8
	PT1/2

Model	ISO	φP.C.D	N-G	DP2(TAP)	K	L	T	T1	H	H1	CH	DP	Weight(kg)
AD50	F03/F05/F07	36/50/70	4-M5/M6/M8	10/12/13	9	162	75	40	90	70	11×11	13	1.4
											#14×14	14	
											#9.7×Ø15		
AD65	F05/F07	50/70	4-M6/M8	14/13	13	202	89	46	107	87	14×14	17	2.3
											#11.7×Ø17	14	
											#9.7×Ø15		
AD80	F07	70	4-M8	12	13	262	101	49.5	126	106	17×17	19	3.9
											#14.7×Ø19	20	
AD100	F07/F10	70/102	4-M8/M10	17/21	19	311	129	61.5	148	128	22×22	26	6.7
											#17.7×Ø22		
AD125	F07/F10	70/102	4-M8/M10	17/21	19	390	151	71.5	174	154	22×22	26	11.3
AD140	F10/F12	102/125	4-M10/M12	27/27	24	431	164	77	192	172	27×27	30	16.4
											#22×22		
AD160	F14	140	4-M16	27	24	506	188	89	216	196	36×36	30	23.7
	#F10/F12	#102/125	#4-M10/M12	-							#27×27		
AD200	F16	165	4-M20	32	36	605	231	115	284	254	46×46	60	45.5
											#36×36	50	
AD250	F16	165	4-M20	32	36	755	301	152	335	305	46×46	60	65.8
AD300	F16/F25	165/254	4-M20/8-M16		36	900	360	170	408	378	55×55	60	78.0

AD300 is expected data.

#Option

Torque Table

Unit:N·m

Model	Angle	4bar	5bar	6bar	Model	Angle	4bar	5bar	6bar
AD50	0°	28	37	41	AD140	0°	754	923	1097
	45°	21	26	31		45°	455	582	668
	90°	38	40	52		90°	720	880	970
AD65	0°	78	95	116	AD160	0°	1062	1312	1600
	45°	49	63	73		45°	758	949	1133
	90°	71	93	107		90°	1320	1635	2027
AD80	0°	143	183	210	AD200	0°	2600	3200	3820
	45°	92	121	144		45°	1500	1950	2400
	90°	133	156	209		90°	2300	2900	3450
AD100	0°	247	292	368	AD250	0°	3950	4850	5750
	45°	165	196	250		45°	2500	3150	3760
	90°	237	301	363		90°	4580	5850	7050
AD125	0°	551	678	794	AD300 (DRAFT)	0°	6732	8416	10099
	45°	360	443	531		45°	3960	4950	5940
	90°	491	613	732		90°	9415	12019	14422

A SERIES (SINGLE ACTING)

SCOTCH YOKE TYPE

Dimension

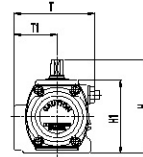
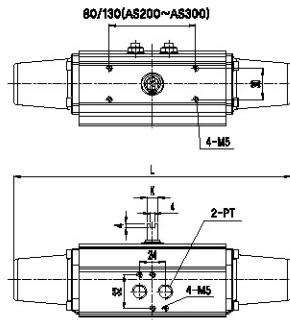

2-PT	
AS50~AS200	PT1/4
AS250~AS300	PT1/4 PT3/8 PT1/2

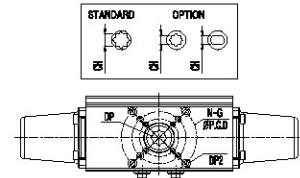

(mm)

Model	ISO	φP.C.D	N-G	DP2(TAP)	K	L	T	T1	H	H1	CH(OPT)	DP	Weight(kg)
AS50	F03/F05/F07	36/50/70	4-M5/M6/M8	10/12/13	9	257	75	40	90	70	11×11	13	1.6
											#14×14	14	
											#9.7×Ø15	14	
AS65	F05/F07	50/70	4-M6/M8	14/13	13	314	89	46	107	87	14×14	17	3.0
											#11.7×Ø17	14	
											#9.7×Ø15	14	
AS80	F07	70	4-M8	12	13	430	101	49.5	126	106	17×17	19	5.3
											#14.7×Ø19	20	
AS100	F07/F10	70/102	4-M8/M10	17/21	19	500	129	61.5	148	128	22×22	26	9.5
AS125	F07/F10	70/102	4-M8/M10	17/21	19	606	151	71.5	174	154	22×22	26	17.6
AS140	F10/F12	102/125	4-M10/M12	27/27	24	682	164	77	192	172	27×27	30	23.9
											#22×22	30	
AS160	F14	140	4-M16	27	24	781	188	89	216	196	36×36	30	36.6
	#F10/F12	#102/125	#4-M10/M12	-							#27×27	30	
AS200	F16	165	4-M20	32	36	982	231	115	284	254	46×46	60	77.2
											#36×36	50	
AS250	F16	165	4-M20	32	36	1108	301	152	335	305	46×46	60	119.6
AS300	F16/F25	165/254	4-M20/8-M16		36	1344	360	170	408	378	55×55	60	145.0

AS300 is expected data.

Option

Torque Table

Unit:N-m

Model	Angle	Spring Torque Middle		Spring Torque Strong		Model	Angle	Spring Torque Middle		Spring Torque Strong	
		spring to	Air to 4.5Bar	spring to	Air to 6Bar			spring to	Air to 4.5Bar	spring to	Air to 4.5Bar
AS50	0°	14	26	17	34	AS140	0°	371	576	480	726
	45°	12	12	15	15		45°	236	265	330	360
	90°	26	14	34	17		90°	447	366	680	430
AS65	0°	35	54	48	70	AS160	0°	550	750	770	1150
	45°	23	28	37	32		45°	420	420	560	560
	90°	54	35	70	48		90°	750	550	1150	770
AS80	0°	60	100	80	130	AS200	0°	1250	1510	1750	2160
	45°	50	50	70	70		45°	740	780	1040	1130
	90°	100	60	130	80		90°	1500	920	2140	1370
AS100	0°	100	190	130	240	AS250	0°	2120	2760	3060	3660
	45°	80	80	110	110		45°	1320	1370	1830	1900
	90°	190	100	240	130		90°	2470	2200	3550	2760
AS125	0°	243	403	358	520	AS300 (DRAFT)	0°	4308	6421	5740	8566
	45°	177	182	215	254		45°	2172	2283	2894	3046
	90°	395	210	445	341		90°	4396	3266	5857	4359

TECHNICAL DATA

Scotch-yoke Type

- Smooth on/off with the torque curve synchronized with valves
- Relatively higher torque than the same model in Rack & Pinion type

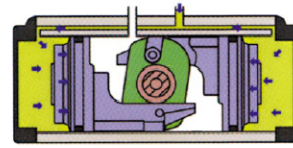

Torque Diagram

Double acting actuators

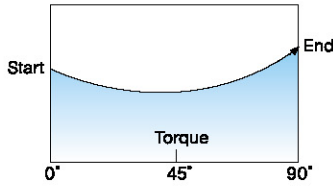

Single acting actuators

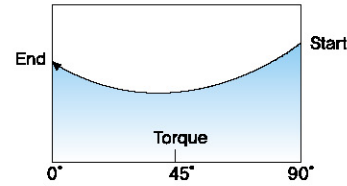
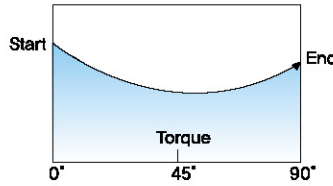

Air Consumption

The air consumption of actuator is calculated by below.

The air consumption is based on 1 action of used valve and do calculate the consumption per an hour

Double acting Actuator (AD Series)	$V = \text{Air Consumption (Liter)}$ $A = \text{Volume "A" (Liter)}$ $B = \text{Volume "B" (Liter)}$ $P = \text{Supply Air pressure (Bar)}$ $N = \text{Number of Operating}$
$= > V = (A+B) * (\frac{P + 1.013}{1}) * N$	
Spring return Actuator (AS Series)	
$= > V = A * (\frac{P + 1.013}{1}) * N$	

Scotch Yoke Type

Fail close

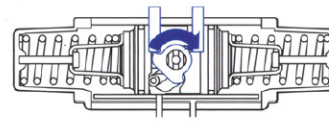
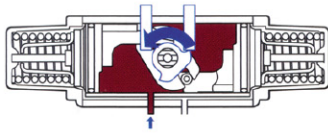
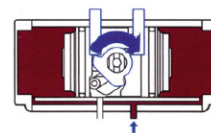
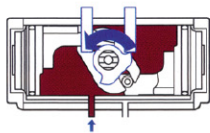

Close "A"

Open "B"

Double acting			Spring return		
Model	A	B	Model	A	B
AD50	0,2	0,2	AS50	0,2	0,2
AD65	0,3	0,3	AS65	0,3	0,3
AD80	0,6	0,5	AS80	0,6	0,5
AD100	1,2	1,1	AS100	1,2	1,0
AD125	2,5	2,2	AS125	2,5	2,1
AD140	3,9	3,5	AS140	3,9	3,3
AD160	4,8	4,3	AS160	4,8	4,0
AD200	6,2	9,0	AS200	6,2	7,6
AD250	8,2	11,7	AS250	8,2	10,0